





T104 Assembly Instruction NO. 1

BEFORE YOU START CHECK ALL THE COMPONENTS NO. 2

A		1	D		5 MM	1
B		2	E		4*20	10
C		M8*25	20			

STEP 1

NO. 3

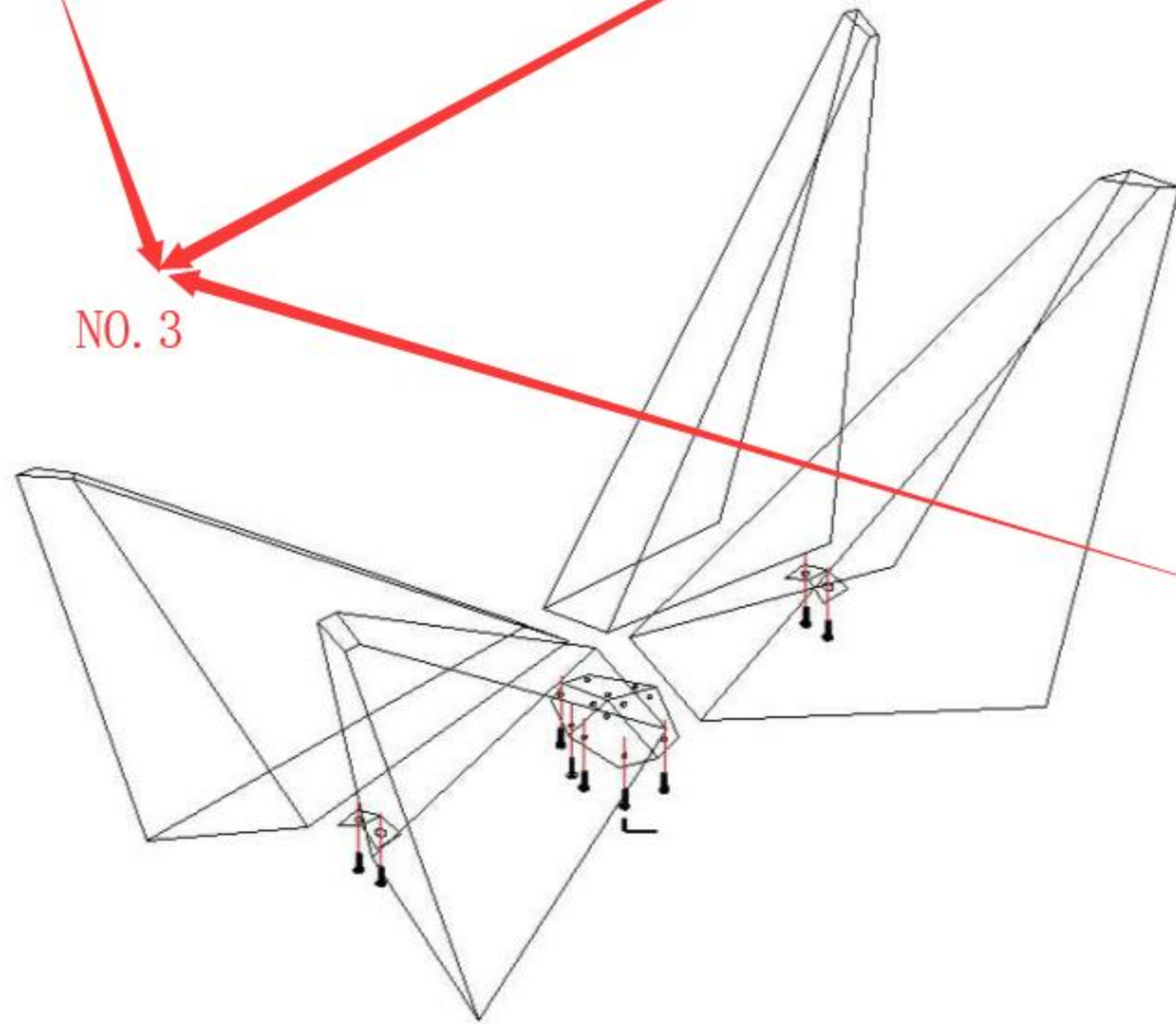

STEP 2

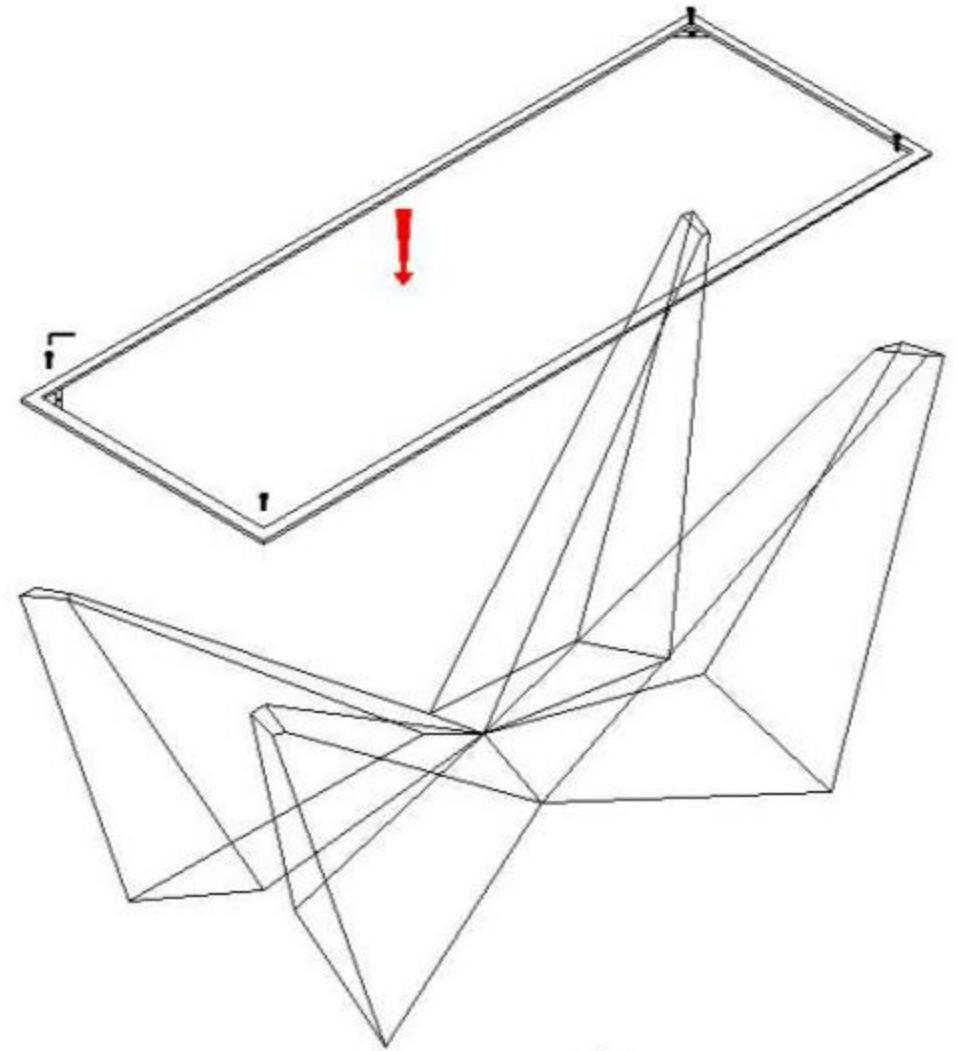

STEP 3

